



**BALTIMORE
AIRCOIL COMPANY**



BCP3D Automatic Dosing and Bleed Control Package

INSTALLATION, OPERATING & MAINTENANCE

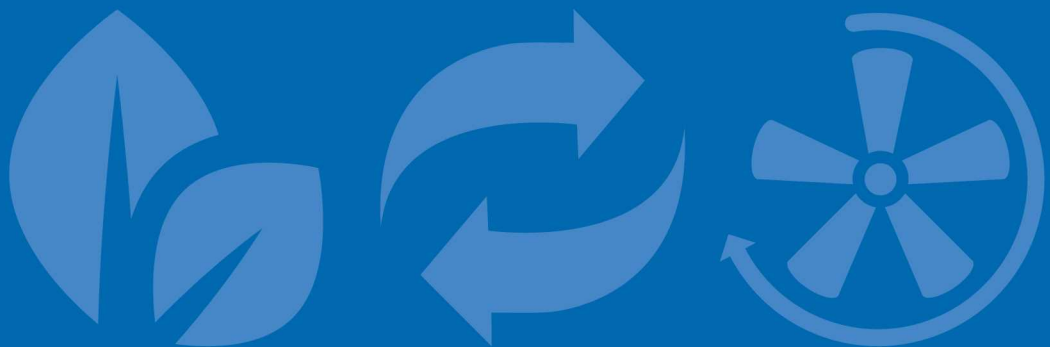



Table of contents

INSTALLATION, OPERATING & MAINTENANCE INSTRUCTIONS

1	Construction Details	3
	BCP3D	3
2	General information	4
	Introduction	4
	Safety precautions	4
	Disposal requirements	5
	Non-walking surfaces	5
	Modifications by others	6
	Warranty	6
3	Water Care	7
	About water care	7
	Biological control	8
	Chemical treatment	9
	Passivation	9
4	Receiving and Installation	10
	Receiving Equipment	10
	Redox (ORP) sensor installation	11
	Piping Interface Connections	12
	Design Criteria	13
	Installation and Anchoring	13
	Electrical Wiring	15
	Dosing Pumps	16
5	Controller Settings	17
	Default parameters and set points	17
	Programming	24
6	Operating Conditions	25
	Function Overview	25
	Maintenance	38
	Troubleshooting	42
7	Further Assistance & Information	45
	More information	45

BCP3D CONSTRUCTION DETAILS

BCP3D

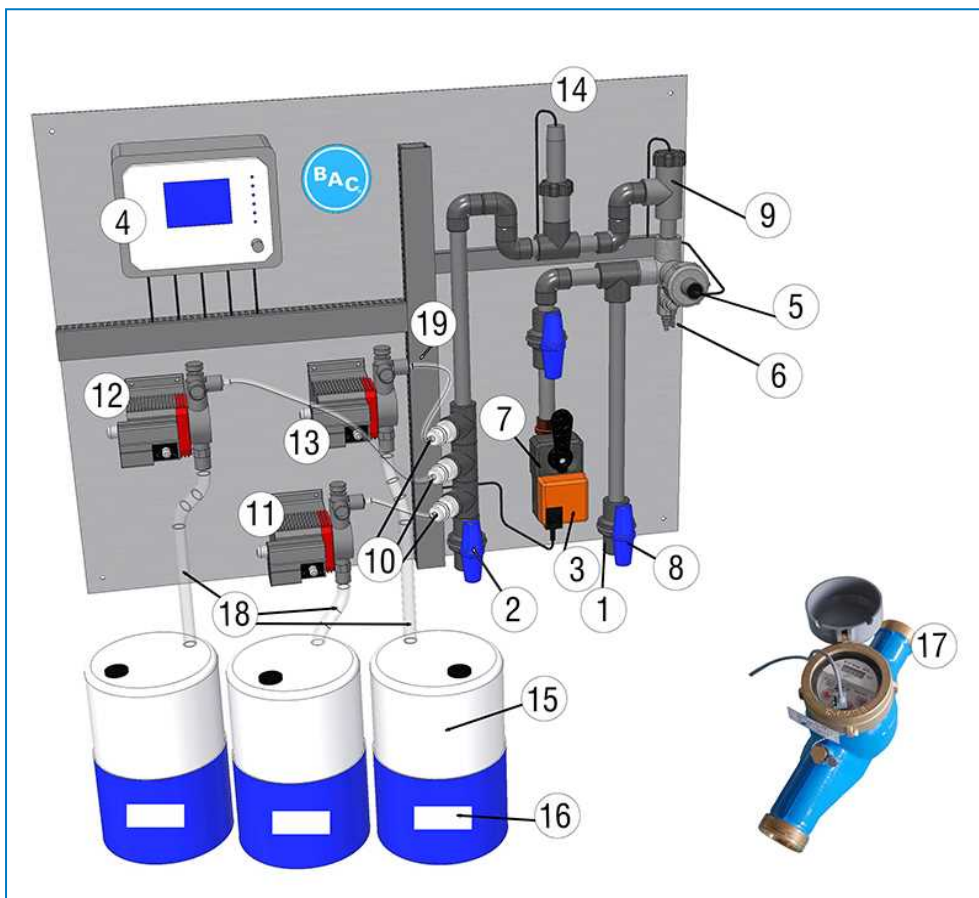

- | | | | |
|----|-----------------------|----|--------------------------------|
| 1 | Fluid inlet coupling | 11 | Pump oxidizing biocide |
| 2 | Fluid outlet coupling | 12 | Pump scale/corrosion inhibitor |
| 3 | Bleed | 13 | Pump secondary biocide |
| 4 | Controller BACT 600 | 14 | Redox sensor |
| 5 | Conductivity probe | 15 | Chemical drum |
| 6 | Sampling point | 16 | Retention |
| 7 | Bleed valve | 17 | Water meter |
| 8 | Insulation valve | 18 | Suction tubing |
| 9 | Flow controller | 19 | Discharge tubing |
| 10 | Chemical injection | | |

Introduction

Baltimore Aircoil Company is the right choice when it comes to having a more efficient, safe and effective system.

The BCP3D automatic dosing and bleed control is a compact package that offers accurate, high quality, liquid chemical based water treatment for evaporative cooling equipment.

The BCP3D control package provides for water meter controlled proportional dosing of a scale and corrosion inhibitor, automatic conductivity based control of dissolved solids level in the recirculating water through blow down, as well as automatic time based dosing of 2 biocides: a primary oxydising biocide based on Redox measurement and a secondary biocide on a periodic basis.

Together with the implementation of a monitoring program, this equipment will assist with the implementation of optimum water quality treatment, with effective and safe control of the water quality and bacteriologic growth, including Legionella Pneumophilia, and reducing operating costs, chemical usage, and maintenance.

Following the guidelines listed in this manual will help to ensure the safety of all personnel who maintain the unit and related equipment. If there are any questions on the procedures or performance of the BCP, contact your local BAC representative. Name, e-mail and phone number can be found on the website www.BACservice.eu

Safety precautions

All electrical, mechanical and rotating machinery constitutes a potential hazard, particularly for those not familiar with its design, construction and operation. Accordingly, adequate safeguards (including use of protective enclosures where necessary) should be taken with this equipment both to safeguard the public (including minors) from injury and to prevent damage to the equipment, its associated system and the premises.

If there is doubt about safe and proper rigging, installation, operation or maintenance procedures, contact the equipment manufacturer or his representative for advice.

When working on operating equipment, be aware that some parts may have an elevated temperature. Any operations on elevated level have to be executed with extra care to prevent accidents.

AUTHORIZED PERSONNEL

The operation, maintenance and repair of this equipment should be undertaken only by personnel authorized and qualified to do so. All such personnel should be thoroughly familiar with the equipment, the associated systems and controls and the procedures set forth in this and other relevant manuals. Proper care, personal protective equipment, procedures and tools must be used in handling, lifting, installing, operating, maintaining and repairing this equipment to prevent personal injury and/or property damage. Personnel must use personal protective equipment where necessary (gloves, ear plugs, etc...)

MECHANICAL SAFETY

Mechanical safety of the equipment is in accordance with the requirements of the EU machinery directive. Depending upon site conditions it also may be necessary to install items such as bottom screens, ladders, safety cages, stairways, access platforms, handrails and toe boards for the safety and convenience of the authorized service and maintenance personnel.

For more information consult your local BAC representative.

ELECTRICAL SAFETY

All electrical components associated with this equipment should be installed with a lockable disconnect switch located within sight of the equipment.

In the event of multiple components, these can be installed after a single disconnect switch but multiple switches or a combination thereof are also allowed.

No service work should be performed on or near electrical components unless adequate safety measures are taken. These include, but are not limited to the following:

- Isolate the component electrically
- Lock the isolation switch in order to prevent unintentional restart
- Measure that no electrical voltage is present any more
- If parts of the installation remain energized, make sure to properly demarcate these in order to avoid confusion

Fan motor terminals and connections may have residual voltage after unit shut-down. Wait five minutes after disconnecting the voltage at all poles before opening the fan motor terminal box.

LOCATION

All cooling equipment should be located as far away as possible from occupied areas, open windows or air intakes to buildings.

LOCAL REGULATIONS

Installation and operation of cooling equipment may be subject to local regulations, such as establishment of risk analysis. Ensure regulatory requirements are consistently met.

Disposal requirements

Dismantling of the unit and treatment of refrigerants (if applicable), oil and other parts must be done with respect to the environment whilst protecting workers from potential risks related to exposure to harmful substances. National and regional legislation for material disposal and protection of workers should be taken into account with regard to:

- Appropriate handling of construction and maintenance materials when dismantling the unit. In particular when dealing with materials that contain harmful substances, such as asbestos or carcinogenic substances.
- Appropriate disposal of the construction and maintenance materials and components such as steel, plastics, refrigerants and waste water according to local and national requirements for waste management, recycling and disposal.

Non-walking surfaces

Access to and maintenance of any component needs to be performed in accordance with all local applicable laws and regulations. If the proper and required access means are not present, temporary structures need to be foreseen. Under no circumstance can one use parts of the unit, that are not designed as an access mean, unless measures can be taken to mitigate any risks that might occur from doing so.



Modifications by others

Whenever modifications or changes are made by others to the BAC equipment without written permission of BAC, the party who has done the modification becomes responsible for all consequences of this change and BAC declines all liability for the product.

Warranty

BAC will guarantee all products to be free from manufactured defects in materials and workmanship for a period of 24 months from the date of shipment. In the event of any such defect, BAC will repair or provide a replacement. For more details, please refer to the Limitation of Warranties applicable to and in effect at the time of the sale/purchase of these products. You can find these terms and conditions on the reverse side of your order acknowledgement form and your invoice.

About water care

In all cooling equipment, operating in evaporative mode, the cooling is accomplished by evaporating a small portion of the re-circulating water as it flows through the equipment. When this water evaporates, the impurities originally present in the water remain. Unless a small amount of water is drained from the system, known as blow down, the concentration of dissolved solids will increase rapidly and lead to scale formation or corrosion or both. Also, since water is being lost from the system through evaporation and blow down, this water needs to be replenished.

The total amount of replenishment, known as make-up, is defined as:

Make-up = evaporation loss + blow down

In addition to the impurities present in the make-up water, any airborne impurities or biological matter are carried into the equipment and drawn into the re-circulating water. Over and above the necessity to blow down a small quantity of water, a water treatment programme specifically designed to address scale, corrosion and biological control should be initiated when the system is first installed and maintained on a continuous base thereafter. Moreover there must be an ongoing programme of monitoring in place to ensure the water treatment system is maintaining the water quality within the control guidelines.

Check and adjustments of blow down depends on the blow down device actual in use.

To prevent excessive build-up of impurities in the circulating water, a small amount of water must be « bled » from the system at a rate to be determined by the water treatment regime. The amount of blow down is determined by the design cycles of concentration for the system. These cycles of concentration depend on the quality of the make-up water and the design guidelines for the quality of the recirculating water given below.

Make-up water to the evaporative unit should have minimum 30 ppm hardness as CaCO_3 .

Where use of a softener is necessary to achieve this, the supply to the evaporative unit should not be totally softened, but blended with the incoming unsoftened water to achieve the minimum hardness between 30 and 70 ppm as CaCO_3 .

Maintaining a minimum hardness in the make-up water offsets the corrosive properties of totally softened water and reduces the reliance on corrosion inhibitors to protect the system.

To control corrosion and scale, the water chemistry of the circulated water has to be kept within the water quality guidelines of the specific materials of construction used, as listed in the following table(s).



	Baltibond® Hybrid Coating and SST304L
pH	6.5 to 9.2
Total hardness (as CaCO ₃)	50 to 750 mg/l
Total alkalinity (as CaCO ₃)	600 mg/l max.
Total dissolved solids	2050 mg/l max.
Conductivity	3300 µS/cm
Chlorides	300 mg/l max.
Sulfates*	350 mg/l max.*
Total suspended solids	25 mg/l max.
Chlorination (as free chlorine / halogen): continuous	1.5 mg/l max.
Chlorination (as free chlorine / halogen): batch dosing for cleaning & disinfection	5-15 mg/l max. for 6 hours max. 25 mg/l max. for 2 hours max. 50 mg/l max. for 1 hour max.

Circulated water quality guidelines for Baltibond® Hybrid Coating

***Note:** Higher concentration of sulfates is allowed, provided the sum of chlorides + sulfates parameters does not exceed 650 mg/l for Baltibond®/SST304L.

***Note:** In case of a HDG coil, passivation of the coil is required. During this period, both the pH and the hardness of the spray water will have more stringent requirements. The pH must be kept between 7 and 8.2, and the hardness must be kept between 100 and 300 ppm.

For Ozone water treatment application:

- Stainless steel 316L execution is required.
- Ozone levels are to be maintained to 0.2 ppm ± 0.1 ppm for at least 90% of the time, with absolute maximum peaks of 0.5 ppm

Cycles of concentration are the ratio of the dissolved solids concentration in the circulating water compared to the dissolved solids concentration in the make-up water. The blow down rate can be calculated as follows:

$$\text{Blow down} = \text{Evaporation loss} / (\text{Cycles of concentration} - 1)$$

The evaporation loss is not only function of the heat load but also depends on climatic conditions, the type of equipment used and the method of capacity control, which is applied. The evaporation loss at summer conditions is approximately 0.431 l/ 1000 kJ heat rejection. This number should be used for blow down valve sizing only and not for the calculation of annual water consumption.

Biological control

The growth of algae, slimes and other micro-organisms, if uncontrolled, will reduce system efficiency and may contribute to the growth of potentially harmful micro-organisms, such as Legionella, in the recirculating water system.

Accordingly a treatment programme specifically designed to address biological control should be initiated when the system is first filled with water and administered on a regular base thereafter in accordance with any regulations (national, regional) that may exist or in accordance with accepted codes of good practice, such as EUROVENT 9-5/6, VDMA Detailsheet 24649 etc.

It is strongly recommended to monitor the bacteriological contamination of the recirculating water on a regular base (for example, TAB test with dip slides on a weekly base) and record all results.

Certain products used for water treatment, particularly some dispersant and bio-dispersant additives, might change the properties of the water (such as the surface tension), which can cause excessive drift loss (water passing through the eliminators). In such case we recommend to review the water treatment (product type, dosage) with your water treatment expert.

In case of doubt, a short test can be performed, after cleaning & disinfection, using fresh water without addition of the concerned chemical (within the limits of the local legislation).

Chemical treatment

1. Water treatment chemicals or non-chemical systems need to be compatible with the materials of construction used in the cooling system including the evaporative cooling equipment itself.
2. In case of chemical water treatment, chemicals should be added to the recirculating water by an automatic feed system. This will prevent localised high concentrations of chemicals, which may cause corrosion. Preferably the water treatment chemicals should be fed into the cooling system at the discharge of the recirculation pump. The chemicals should not be fed in concentrated form, nor batch fed directly into the cold water sump of the evaporative cooling equipment.
3. BAC specifically discourages acid dosing as a means of scale control (unless under certain strict circumstances for open circuit cooling towers with very large system volume and remote sump, or constructed from stainless steel).
4. A competent water treatment company should be consulted for the specific water treatment programme to be applied. Next to the supply of dosing and control equipment and chemicals, the programme should include regular monthly monitoring of the circulating and make up water quality.
5. If it is proposed to operate a treatment programme outside the BAC Water Quality Control Guidelines, the BAC factory warranty may be invalidated if the water quality is persistently outside the Control Guidelines, unless specific prior written BAC approval. (Some parameters may be exceeded under certain strict circumstances.)

It is strongly recommended to check the key parameters of the circulating water quality on a monthly base. See table: "Circulated water quality guidelines". All test results need to be recorded.

Passivation

When new systems are first commissioned, special measures should be taken to ensure that galvanized steel surfaces are properly passivated to provide maximum protection from corrosion. **Passivation** is the formation of a protective, passive, oxide layer on galvanized steel surfaces.

To ensure that galvanized steel surfaces are passivated, the pH of circulating water should be kept between 7.0 and 8.2 and calcium hardness between 100 and 300 ppm (as CaCO₃) for four to eight weeks after start-up, or until new zinc surfaces turn dull grey in colour. If white deposits form on galvanized steel surfaces after the pH is returned to normal service levels, it may be necessary to repeat the passivation process.



Full stainless steel units and units protected by the Baltibond® hybrid coating do not require passivation. An exception to this are units with a galvanized steel coil bundle which do still require the proper passivation procedure as described here in this section.

In case you can't keep the pH below 8.2, a secondary approach is to conduct a chemical passivation using inorganic phosphate or film-forming passivation agents. Consult your water treatment specialist for specific recommendation.

4

BCP3D RECEIVING AND INSTALLATION

Receiving Equipment

Before accepting the BCP3D equipment and prior to signing the bill of lading, all equipment should be checked thoroughly for any shipping damage. Make sure that all required equipment noted on the bill of lading is received. Check the model and serial number against the packing list.

Receiving / Inspection check list

- (1) BCP3D panel
- (3) chemical drums
- (1) water meter
- (1) set of 3 suction strainers and suction tubes
- (1) Redox (ORP) sensor amplifier wired to panel but sensor itself kept inside a special liquid filled storage chamber





Redox (ORP) sensor installation



The pre-amplifier is wired and protected with a red cap.



The sensor is shipped loose, within a closed housing filled with liquid solution.

TO BE DONE JUST BEFORE START-UP:

- Remove the red cap from the pre-amplifier.
- Remove the sensor from its housing and mount it on the pre-amplifier.



- Install the assembled part into the chamber.



CAUTION

Do not allow the pre-amplifier to enter in contact with water before installing the sensor.



CAUTION

Do not keep the sensor exposed to dry air.

Piping Interface Connections

The BCP3D should be installed using the following guidelines:

1. Proper installation of the interconnecting piping is critical to the BCP3D system effectiveness.
2. BCP3D inlet, outlet and drain connection are standard glued on PVC connections.
3. Do not reduce the pipe size on the connections to and from the BCP3D or of the drain line. Increasing the pipe size is acceptable.
4. Refer to recommended installation schematics provided with the submittal packages for the various system configuration options:
 - (1) BCP3D for use with closed circuit evaporative equipment
 - (1) BCP3D for use with closed circuit evaporative equipment with a separate booster pump
 - (1) BCP3D for use with single open circuit evaporative equipment
 - (1) BCP3D for use with multiple open circuit evaporative equipment in parallel

Design Criteria

The BAC standard BCP3D water treatment system is designed for use with evaporative cooling equipment. The number and sizing of BCP3D is function of the cooling system design load conditions, expected operating cycle of concentration (hence water usage), and application for open and closed circuit evaporative cooling equipment. Determination of these aspects is made by a qualified BAC representative. Changes in system load which increase the bleed rate may require an increase in the size of each BCP3D .

Installation and Anchoring

The BCP3D should be located as close as possible to the sump or system interface piping: maximum 7 m distance.

For longer distance, it is recommended to install a separate booster pump (by others).

The BCP3D is designed to receive water flow at the inlet from pressurized sources, such as the pressure side of the spray pump or condenser water lines. The pressure at the inlet of the BCP3D should not exceed 60 kPa.

The discharge water from the BCP3D should be returned on a non-pressurized point, preferably the cooling water sump or the suction side of the system circulating pump (for open cooling towers).

The drain should be connected directly to a drain collecting point.

The BCP3D can be mounted and supported to the cooling tower panel, to a wall or support structure using a variety of anchoring methods. When installed outside it is recommended to install the BCP3D above the cooling tower water level to allow free piping drainage when idle.

The BCP3D is equipped with valves at the inlet, discharge and drain.

1. The inlet and drain valve should be kept fully open during normal operation.
2. The return outlet valve might be throttle to reduce water flow during measuring cycle
3. Note: The drain valve might be throttled slightly to reduce bleed water flow if the flow controller switch off during bleed cycle. Make sure however sufficient bleed rate can be guaranteed at nominal operation load.
4. The BCP3D is designed to handle a maximum water pressure of 60 kPa at 55°C.

DRUMS AND BUNDS

The drums and bunds should be positioned directly below panel as per sketch below.



Example of installation

CONNECTION BETWEEN DRUMS AND DOSING PUMPS

Install suction strainer into the drum and using the plastic tubing connect each drum to the respective dosing pumps. Make sure that the suction strainer stands vertically in the drum. See more details below.



Tubing and suction head with strainer.



Mounting of tubing on suction head.



Suction head to be installed inside drum.



Suction head should be installed vertically.
Adjust tubing length accordingly.



Mounting detail tubing on pump head.



Overview pump tubing connection to drum.

WATER METER

The water meter should be installed in the make up line to the cooling towers

- Adapters supplied by others. It is recommended to install insulating valve for easier maintenance.
- Position the water meter with the arrow in the water flow direction
- Flush the piping before installation, to prevent dirt to enter the water meter. Water meter should be protected from freezing (protected room or insulation and tracing)
- Make sure the water meter screen can be viewed and read at any time

 Prestrainer should be cleaned on a yearly basis.

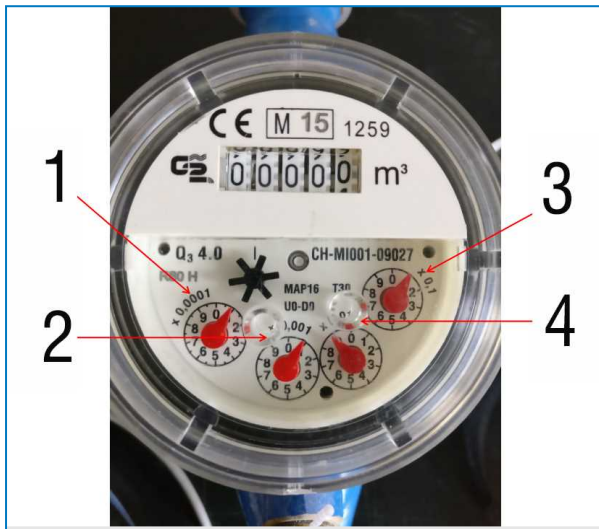

Water meter reading information

1. 1 rotation = 1L; 1 graduation = 0,1 L
2. 1 rotation = 10L; 1 graduation = 1 L
3. 1 rotation = 1m³; 1 graduation = 100 L
4. 1 rotation = 100L; 1 graduation = 10 L

Electrical Wiring

Refer to the wiring diagram of the submittal package.

The BCP3D is suitable for connection to networks of 110V - 230V and 50 - 60 Hz (AC POWER).
 The BCP3D panel is pre-wired and only requires a main power supply to the controller BACT 600.
 A general alarm output is also available as indicated on the wiring.
 Wiring of the water meter to the controller BACT 600 (by others).

Optional when specified at order: Analogic output 4-20 mA for conductivity.

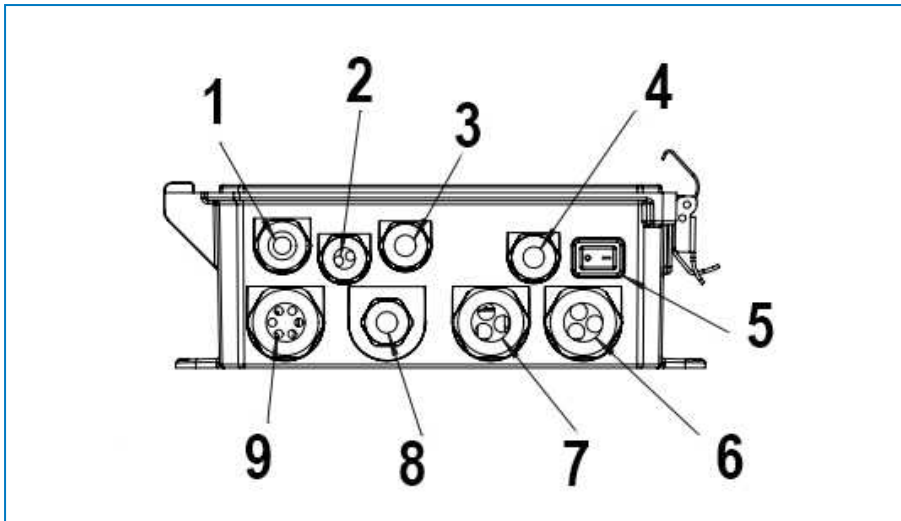

- 1. Ethernet
- 2. 4-20 mA outputs
- 3. Sensor 1
- 4. Power in
- 5. Power switch
- 6. Relays
- 7. Relays
- 8. Sensor 2
- 9. Digital inputs

Dosing Pumps

Dosing pumps are pre mounted on BCP panel and pre wired to the controller.



Refer to specific dosing pumps operating manual supplied with the submittal package for specific questions regarding dosing pumps.

BCP3	BCP3D20	BCP3D32	BCP3D50
Inhibitor pump	316668	316669	316670
Non oxidising biocide pump	316668	316669	316671
Oxidising biocide pump	316669	316670	316672

BAC Part number	Type	Flow (l/h)	Pressure (bar)
316668	EJ-B11-ER	1,8	10
316669	EJ-B16-ER	3	7
316670	EJ-B21-ER	4,8	4
316671	EWN-C21-VCER	7,8	7
316672	EWN-C21-VCERA	6,6	7



BCP3D CONTROLLER SETTINGS

Default parameters and set points

The BACT 600 controller has been preprogrammed specifically for use with BAC evaporative cooling equipment.

MENU INPUT

S11 - Conductivity

LoLo Alarm (Very low alarm)	200 μ S/cm
Low Alarm	200 μ S/cm
High Alarm	3500 μ S/cm
HiHi Alarm (Very high alarm)	3500 μ S/cm
Deadband	25 μ S/cm
Alarm suppression	none
Reset Calibration values	
Cal Req'd Alarm	365 days
Smoothing factor	0 %
Cell Const	1,000 1/cm
Cable length	6,10 m
Gauge	22 awg/0,35mm ²
Default temp	25 °C
Temp Comp	NaCl
Units	μ S/cm
Name (change with language, default is English)	Conduct
Type	Contacting Cond



S12 - Temperature

LoLo Alarm (Very low alarm)	1,0 °C
Low Alarm	1,0 °C
High Alarm	50,0 °C
HiHi Alarm (Very high alarm)	50,0 °C
Deadband	1,0 °C
Reset Calibration values	
Cal Req'd Alarm	0 days
Alarm suppression	none
Smoothing factor	0 %
Name (change with language, default is English)	Temp
Type	10K Therm

S21 - Redox

LoLo Alarm (Very low alarm)	50,0 mV
Low Alarm	50,0 mV
High Alarm	850,0 mV
HiHi Alarm (Very high alarm)	850,0 mV
Deadband	10,0 mV
Reset Calibration values	
Cal Req'd Alarm	365 days
Alarm suppression	none
Cable length	6,10 m
Gauge	22 awg/0,35mm ²
Smoothing factor	0 %
Name (change with language, default is English)	ORP Redox
Type	ORP

S22 - Not used

Element - no element

D1 - Flow detector

Open Msg (change with language - default is English)	No Flow
Closed Msg (change with language - default is English)	Flow
Interlock	When open
Alarm	When open
Total time	When closed
Reset time	N/A
Name (change with language - default is English)	Flow switch
Type	DI State

D2 - Water meter

Totalizer Alarm	0
Reset flow total	
Scheduled reset	Disabled
Volume/Contact	1 l
Flow units	l
Name (change with language - default is English)	Water meter
Type	Contacting FM

D3 - Not used

Type - no input

D4 - Not used

Type - no input

D5 - Not used

Type - no input

D6 - Not used

Type - no input



MENU OUTPUT

R1 - Bleed

HOA Setting	Auto
Setpoint	1200 μ S/cm
Deadband	25 μ S/cm
Duty Cycle Period	0:00
Duty Cycle	100,0 %
Output Time Limit	3:00:00
Reset Output Timeout	
Interlock Channels	D1
Activate with Channels	None
Min Relay Cycle	0 sec
Hand Time Limit	0:10:00
Input	Conduct (S1)
Direction	Force Lower
Name (change with language, default is English)	Bleed
Mode	On/Off

R2 - Inhibitor dosing based in water meter

HOA Setting	Auto
Feed duration	00:02:00
Accum Volume	200 l
Reset timer	
Output Time Limit	1:00:00
Reste Output Timeout	
Interlock channels	D1
Activate with channels	None
Min Relay Cycle	0 sec
Hand Time Limit	0:10:00
Input	Watermeter (D2)
Name (change with language - default is English)	Inhib
Mode	Flow Timer

R3 - Timer dosing of biocide

HOA Setting	Auto
Event 1	Repetition: 1 week Day: Monday Start time: 8:00:00 Duration: 0:15:00
Event 2	Repetition: 1 week Day: Wednesday Start time: 8:00:00 Duration: 0:15:00
Event 3	Repetition: 1 week Day: Friday Start time: 8:00:00 Duration: 0:15:00
Event 4...10	Inactive
Bleed	Bleed (R1)
Prebleed time	0:00:00
Prebleed to	1150 μ S/cm
Cond Input	Conduct (S1)
Bleed lockout	1:00:00
Interlock channels	D1
Activate with channels	None
Min Relay Cycle	0 sec
Hand time limit	0:10:00
Name (change with language - default is English)	Bio Timer
Mode	Biocide Timer



R4 - Redox based dosing of biocide

HOA Setting	Auto
Setpoint	200,0 mV
Proportional Band	100,0 mV
Sample period	0:02:00
Duty Cycle	100,0 %
Output Time Limit	0:00:00
Reset Output Timeout	
Interlock channels	D1
Activate with channels	None
Min Relay Cycle	0 sec
Hand Time Limit	0:10:00
Input	ORP Redox (S21)
Direction	Force Higher
Name (change with language - default is English)	Bio2 ORP
Mode	Time Proportional

R5 - Not used

R6 - Alarm

HOA Setting	Auto
Alarm mode	All Alarms
Output	Normally open
Interlock channels	None
Activate with channels	None
Min Relay Cycle	0 sec
Hand Time Limit	0:10:00
Name (change with language - default is English)	Alarm
Mode	Alarm Output

MENU CONFIGURATION

Global Settings

Date	
Time	
Global Units	Metric
Temp Units	°C
Alarm Delay	0:00
HVAC Modes	Enabled
Language (change with language, default is English)	English

Security Settings

Controller Log Out	
Security	Disabled
Local Password	Default is 5555

Display Settings

Home 1	Conduct (S11)
Home 2	Temp (S12)
Home 3	ORP Redox (S21)
Home 4	None
Adjust Display	
Key Beep	Disabled

File Utilities

Data Log Range	3 months
Log Frequency	15 minutes

Controller Details

Not applicable	
----------------	--



Programming

The effective bleed set point should be defined by the owner or by its representative (contractor, water treatment specialist,...) in function of the following parameters:

- Make Up water quality parameters
- Materials of construction: refer to the "Water Care" on page 7 and the submittal information of the BAC equipment
- The water treatment program implemented, including formulation and concentration of biocides and anti-scale / anti-corrosion inhibitors
- The system volume to be treated

Anti-scale and anti-corrosion dosing is made in function of the make up water quality. An impulse will be given to the dosing during XX minutes / YY seconds after each XXX liters of make up water.

One biocide (Bio 1) will be dosed in shock during X minutes / YY seconds at regular interval (weekly or daily mode). Pre-bleed is done before dosing and bleed lock out to be made for X hours / YY minutes after dosing. The second biocide (Bio2) will be an oxidizing biocide that will be dosed in function of a Redox measurement, providing indirect correlation with the remaining oxidizing biocide value in the system.

FOLLOWING VALUES NEED TO BE ADJUSTED / CHECKED PRIOR TO START UP:

Global settings

- Date (If required)
- Time (If required)

Input Menu

- D2 water meter

Output Menu

- R1 Bleed Valve - Conductivity Set Point
- R2 Inhibitor dosing based on water meter
- R3 Time dosing of biocide
- R4 Redox based dosing of biocide
- Optional - Analog output conductivity 4-20 mA

6

BCP3D OPERATING CONDITIONS

Function Overview

FRONT PANEL

















DISPLAY - TOUCH SCREEN



A Home screen is displayed while the controller is on. This display shows a user-defined list of input readings or status of outputs. Touching any of the items on the Home screen will bring up the item's Details screen, where you can access calibration and settings menus. Arrow icons page up or down to additional inputs if more than three are configured to be viewed. Touching the Menu icon brings up the Main Menu screen. Easy to understand icons on the bottom of the screens, and areas within the screen that are outlined in black, bring up new screens. These reverse the black and white touched to give visual feedback.

ICONS

The following icons appear on the Home screen. Touch any icon to get to the related menu.

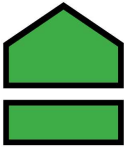
	Alarm Menu
	Inputs Menu
	Outputs Menu
	Configuration Menu
	HOA Menu
	Graph Menu
	Home Page

Other icons may appear in the Menu screen.	
	<p>Calibration icon appears in sensor Inputs Menu and brings up the Calibration Menu</p>
	<p>Graphic icon appears in Inputs Menus and brings up the Graphs Menu showing that input</p>
	<p>Edit icon appears in Input and Output details menus and allows the editing of settings</p>
	<p>Information icon appears in Input and Output menus in place of the Edit icon and is used to leave edit mode and return to viewing information related to that Input or Output</p>
	<p>Close icon closes a menu and returns to the previous menu</p>
	<p>Confirmation saves changes and returns to the previous menu</p>
	<p>Character Delete icon erases part of an alphanumeric entry</p>
	<p>Filter icon is used in menus to limit the choices displayed when selecting items from a list</p>
	<p>Shift icon is used for upper-case characters</p>

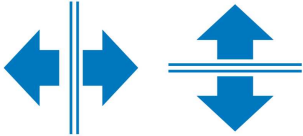
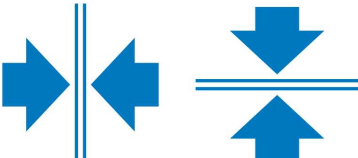
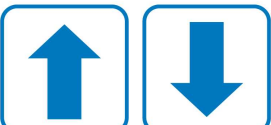
Other icons may appear in the Menu screen.	
	<p>Double Arrow icons appear in Graphs Menu and move the time frame of the graph</p>
	<p>Calendar icon appear in Graphs Menu and brings up the Time Range settings</p>
	<p>Dim and Bright icons appear in Display Settings menu</p>
	<p>Split icons appear in Edit Home Screen Layout and are used to change a larger cell into two smaller ones</p>
	<p>Merge icons appear in Edit Home Screen Layout and are used to change two smaller cells into one large one</p>
	<p>Move Up or Down icons appear in the Edit Home Screen Layout and are used to move a parameter up and down in it's position on the screen</p>

Overview of the use of keys

Changing numeric values

- To change a number, use the Character Delete icon on the digit to be changed.
- If the new number will be negative, start with touching the minus sign, then use the numeric touchpad and decimal point to type the number. Some entries must be integers and the decimal will be ignored and the setting rounded to the nearest integer.
- Once the value of the number is correct, touch the Confirm icon to store the new value to memory, or touch the Cancel icon to leave the number at its previous value and go back.

Changing names

- To change the name used to identify an input or output, use the Move Cursor icon on the character to be changed and change it using either the Make Character Higher or Lower icons.
- Upper case and lower case letters, numbers, a blank space, period, plus and minus symbols are available.
- Move the cursor to the right and modify each character.
- Once the word is correct, use the Confirm icon to store the new value into memory, or use the Cancel icon to leave the word at its previous value and go back.

Choosing from a list

- Selecting the type of sensor, the units of measure of an input, or the control mode used for an output, the selection is picked from a list of available options.
- Touch the Page Up or Down icons to highlight the desired option, and then touch the Confirm icon to store the new option into memory, or touch the Cancel icon to leave the option at its previous value and go back.

Hand-Off-Auto relay mode

- Touch the desired mode
- In hand mode the relay is forced on for a specified amount of time and when that time is up the relay returns to its previous mode.
- In off mode the relay is always off until taken out of off mode.
- In auto mode the relay is responding to control set points.
- Touch the Return icon and go back to the relay settings.

STARTUP

Initial startup

After having mounted the enclosure and wired the unit, the controller is ready to be started. Plug in the controller and turn on the power switch to supply power to the unit. The display will briefly show the model number and then revert to the normal summary display.

To return to the summary display, touch the Main Menu icon and then touch the Home Page icon.

Settings menu

Choose language

- Touch the Config icon.
- Select Global Settings.
- Scroll Down until the English word "language" is displayed and then touch it.
- Scroll Down until your language is displayed and select it.
- Exit with the X icon.

Set date (if necessary)

- Touch the Config icon.
- Select Global Settings.
- Swipe up or down until Date is displayed, and then touch it.

- Highlight the setting you want to change, and then use the numeric touchpad to change the date.
- Touch the Confirm icon to accept the change.

Set time (if necessary)

- Touch the Config icon.
- Select Global Settings.
- Swipe up or down until Time is displayed, and then touch it.
- Highlight the digit you want to change, and then use the numeric touchpad to change the time.
- Touch the Confirm icon to accept the change.

Inputs S11, S12 and S21

- Touch the Input icon.

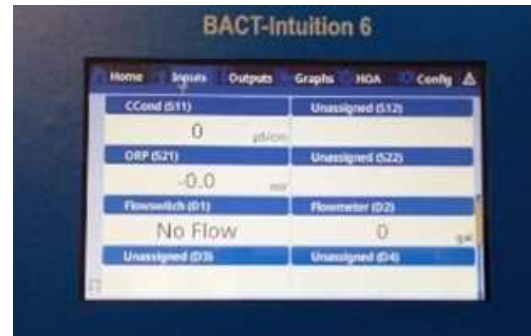

S11: Conductivity

Preprogrammed with default values by BAC, see "Default parameters and set points" on page 17

S12: Temperatures

Preprogrammed with default values by BAC, see "Default parameters and set points" on page 17

S21: Redox

Preprogrammed with default values by BAC, see "Default parameters and set points" on page 17

D1 Flow switch

Preprogrammed by BAC, no action required

D2 Water meter

Note the K value of the water (L/impulse) and enter as alter value as required.

Default preprogrammed value is 1 liter / impulse

- Select input screen
- Select water meter (D2)
- Press the Pencil key
- Press the Scroll Down key until the "volume/contact" is highlighted
- Press the Enter key
- Use the touchpad to change value if required (default 1 liter / impulse)
- Press the Confirm key V to accept the change

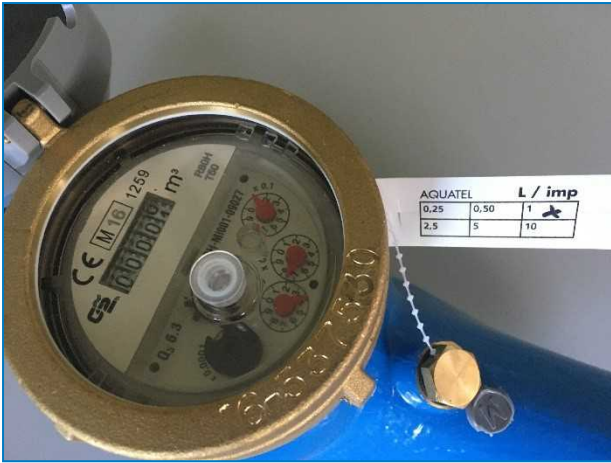

Water meter

Outputs R1, R2, R3 and R4

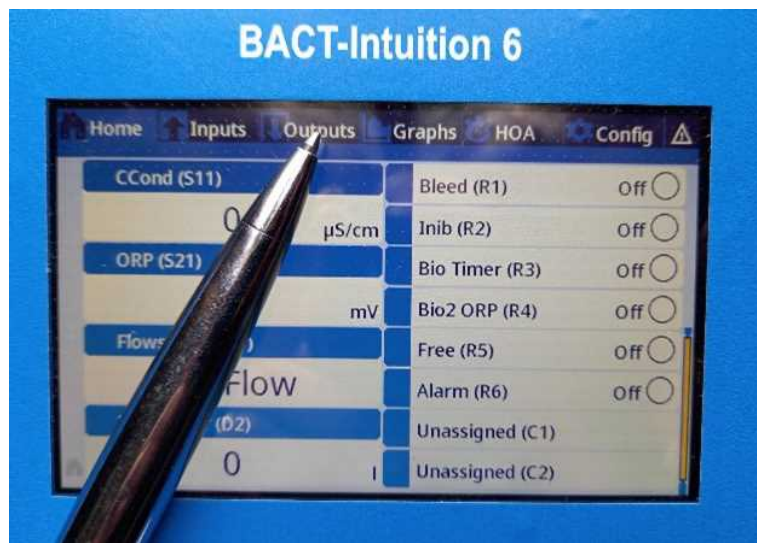
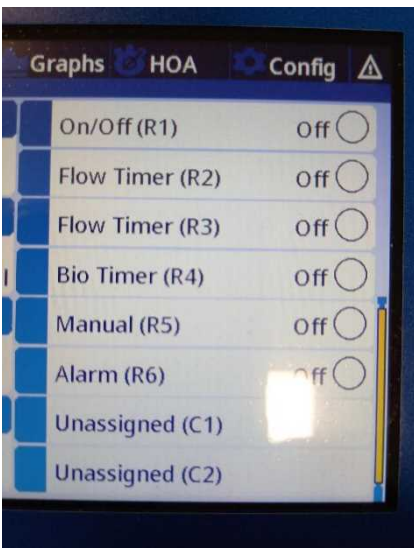

R1: Bleed valve

Preprogrammed with default values by BAC, see "Default parameters and set points" on page 17
 Enter the correct bleed set point with following procedure:

Select bleed (R1)



Touch the Pencil icon



Select Setpoint

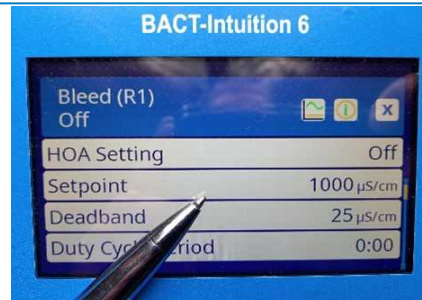

Use the numeric touchpad to change value if required (default is 1200).



Touch the Confirm icon to accept the change



R2: Scale and Corrosion Inhibitor Dosing

Preprogrammed with default values by BAC, see "Default parameters and set points" on page 17

Enter the correct values with following procedure:

<p>Touch the Inhib R2 icon</p>	
<p>Touch the pencil icon</p>	
<p>Touch Feed duration (default is 2 minutes)</p>	
<p>Change the duration (HH:MM:SS) with the touch pad</p>	
<p>Validate</p>	
<p>Touch the Accumulator Volume Setting Change the volume (liter) with the touchpad (default is 200 liters) Validate</p>	

R3: Bio Timer

Preprogrammed with default values by BAC, see "Default parameters and set points" on page 17

Enter the correct values with following procedures:

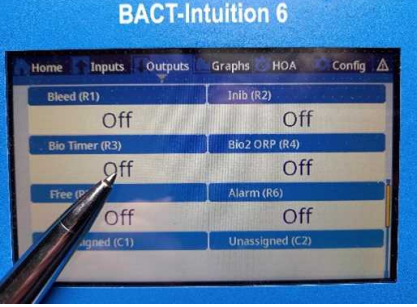
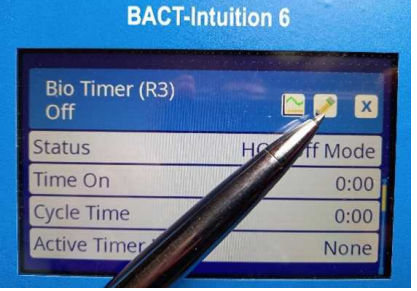
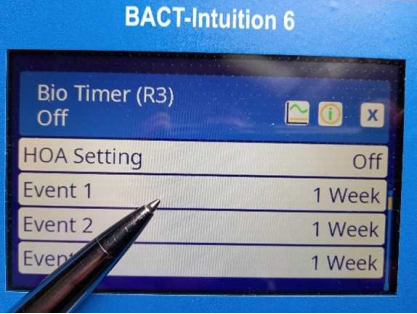
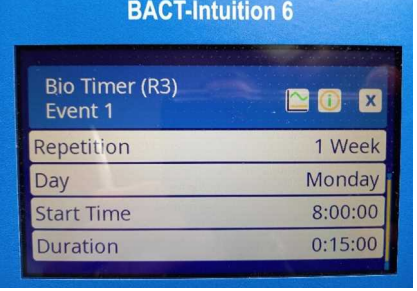
<p>Touch the Bio1 Timer icon</p>	
<p>Touch the Pencil icon</p>	
<p>Touch "Event 1" to open a submenu</p>	
<p>Use the keyboard that appears on the screen to change: Repetition: daily/1 week, 2 weeks, 4 weeks (default is 1 week) Edit also in the same way: Day (default is Monday, Wednesday and Friday dosing) Start Time Duration</p>	
<p>Touch X to exit and return to the Relay Menu</p> <p>Repeat for each event (3 events programmed by default event 1 Monday, event 2 Wednesday and event 3 Friday)</p> <p>Validate</p>	

Pre-bleed and Bleed lock out

This functionality allows to force the bleed before dosing the biocide in the system and to block the bleed for a given time after dosing, hence allowing biocide to act and prevent to be purged and diluted.

Program the Pre-bleed and Bleed lock out

- Still in the Bio Timer R3 relay output menu
- Touch the Settings icon
- Touch the Scroll Down icon until the "Pre-bleed" is highlighted (Default is 1150 MicroSiemens)
- Recommended setting is same as bleed set point minus dead band (typically 50 MicroSiemens)
- Adjust value as required
- Touch the Scroll Down icon until the "Bleed Lock out" is highlighted (Default is 1.00 Hour)
- Adjust value as required
- Validate

R4: Bio2 ORP



Preprogrammed with default values by BAC, see "Default parameters and set points" on page 17

Enter the correct values with following procedures:

Select the Bio2 ORP R4 relay

- Program the setting for the oxidizing biocide dosing

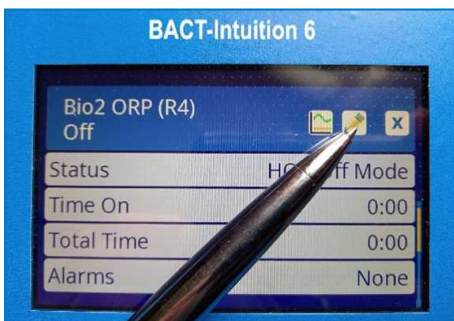

- Touch the Pencil icon
- Touch Setpoint (default is 200 mV)

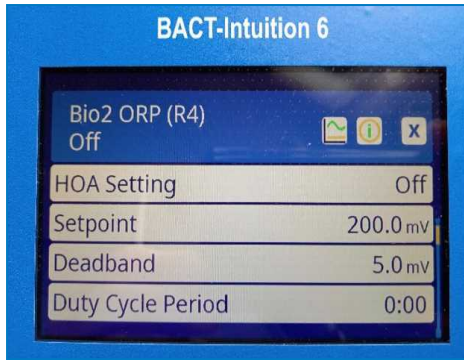

- Select and edit Setpoint as defined using the screen touchpad
- Validate

ANALOG OUTPUT 4 - 20 MA (OPTIONAL EXECUTION WHEN ORDERED)

This option will allow you to get the output value for the conductivity (S11) and the Redox (ORP-21). Press the Settings icon view or change the settings related to the analog output.

4 mA Value	Enter the value of the conductivity to correspond to 4 mA output signal (default 0 MicroSiemens)
20 mA Value	Enter the value of the conductivity to correspond to 20 mA output signal (default 3600 MicroSiemens)

FILE UTILITIES

Allows you to export event logs to a USB stick, export the configuration and settings (for later back-up or program additional controllers in the same way).

File Transfer Status	Displays the status of the last attempt to export a file.
Export Event Log	Save the event log file to a USB stick. This records set point changes, user calibrations, alarms, relay state changes, file exports, etc.
Export System Log	Save the system log file to a USB stick. This records hardware changes, software upgrades, automatic calibrations, power loss, system-level issues, etc.
Import User Config File	Remove power from the controller and insert a USB stick that contains the settings that you want to import to this controller (see Export User Config File below). Press the Enter key and then press the Confirm key to transfer those settings to this controller.
Export User Config File	The user configuration file contains all settings for the controller. Enter this menu to save the controller's settings to a USB stick for using later to restore settings to this controller, or to program additional controllers with the same settings as this one. It takes several minutes to create the file and transfer it to the stick. Remove power from the controller and insert a USB stick. Press the Enter key and then press the Confirm key to transfer a file containing the controller's settings to the USB stick.

Restore Default Config	Enter this menu to restore all of the settings to the factory default values. Any changes to settings that were previously made will be lost!
Software Upgrade	Remove power from the controller and insert a USB stick that has the upgrade file stored in the root directory into the USB connector. Press the Enter key, and then press the Confirm key to start the upgrade.

 Remove power before inserting or removing the USB stick.

NORMAL STARTUP

Startup is a simple process once your set points are in memory.

- Fill the drums with the appropriate chemicals
 - Turn on the controller, calibrate the sensor if necessary (normally not required)
 - Prime the dosing pumps
 - Touch Output Menu
 - Touch Inhib R2
 - Touch Utilities
 - Touch HOA Menu and switch to "Hand" mode
 - The control will start dosing manually for maximum 10 minutes (afterwards it will return to AUTO mode).
- Push the "START" button on the relevant dosing pump to allow the pump to operate**
- Make sure that the dosing pump is operating and that the liquid fills in the tubing until injection point on BCP panel. At this stage, you may turn the pump back to AUTO mode.

Repeat operation with BIO TIMER R3

Push the "START" button on the relevant dosing pump to allow the pump to operate

Repeat operation with BIO 2 ORP R4

Push the "START" button on the relevant dosing pump to allow the pump to operate

- The BCP is now ready to control and dose.

SHUT DOWN

To shut down the controller, simply turn off the power. Programming remains in memory.

 For more details on controller functionality, refer to the BACT 100 controller manuals as per submittal package.



Maintenance

The controller itself requires very little maintenance. Wipe with a damp cloth. Do not spray down the controller unless the enclosure door is closed and latched.

CONDUCTIVITY SENSOR CLEANING



The controller must be recalibrated after cleaning the sensor.

Frequency

The sensor should be cleaned periodically. The frequency required will vary by installation. In a new installation, it is recommended that the sensor be cleaned after two weeks of service. To determine how often the sensor must be cleaned, follow the procedure below.

1. Read and record the conductivity
2. Remove, clean and replace the conductivity sensor
3. Read conductivity and compare with the reading in step 1 above.

If the variance in readings is greater than 5%, increase the frequency of sensor cleaning. If there is less than 5% change in the reading, the sensor was not dirty and can be cleaned less often.

Cleaning procedure

The sensor can normally be cleaned using a cloth or paper towel and a mild detergent. If coated with scale, clean with a dilute (5%) solution of hydrochloric acid solution for at least 1 minute.

Occasionally an electrode may become coated with various substances that require a more vigorous cleaning procedure. Usually the coating will be visible, but not always.

To clean a severely coated electrodeless conductivity sensor, scrub with a toothbrush or stiff bottle brush. Soap or hand cleaner may help. If coated with scale, clean with a dilute (5%) hydrochloric acid solution. Harsh abrasives should be avoided. Rinse the sensor thoroughly before returning to service.

To clean a severely coated flat surface cooling tower electrode, use fine grit abrasive, such as emery paper. Lay the paper on a flat surface and move the electrode in a back and forth motion. The electrode should be cleaned parallel to the carbon electrodes, not perpendicular.

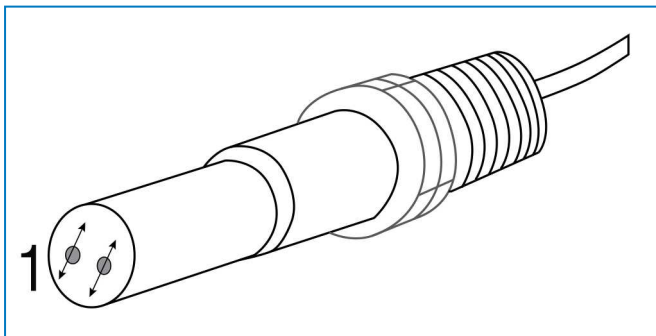

Cleaning a flat contacting conductivity electrode. 1. Clean in this direction.

FLOW SWITCH CLEANING

Frequency

The flow switch should be checked periodically. This to make sure it is free and the chamber is free from any debris that would prevent its proper operation.

The frequency required will vary by installation.

Check the conductivity monthly with a handheld device and compare with the value indicated on the controller. After cleaning, if the value deviates from the reading on the handheld device, see calibration procedure below.

CALIBRATE THE CONDUCTIVITY SENSOR

To calibrate the sensor, from the home page return to the list of inputs:

Touch the Conductivity sensor shortcut (S11)

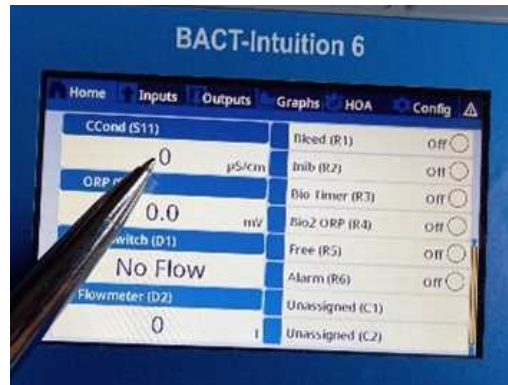

Touch the Target icon
Select one of the Calibration routines



Calibration

Press the Calibration key to calibrate the sensor

Select the calibration to perform

- One point process
- One point buffer
- Open air

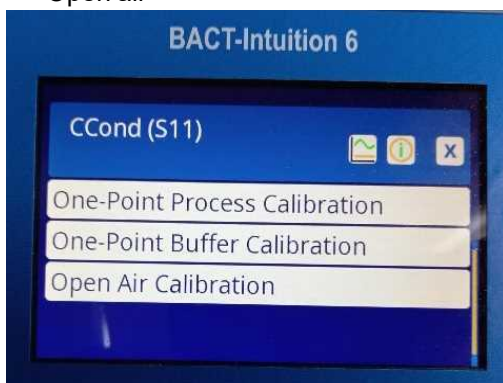

CALIBRATE THE ORP SENSOR

To calibrate the sensor, from the home page return to the list of inputs
Highlight ORP sensor (S21) and select

Calibration

Press the calibration key to calibrate the sensor

Select the calibration to perform (3 possibilities)

- One point process
- One point buffer (recommended)
- Two point buffer

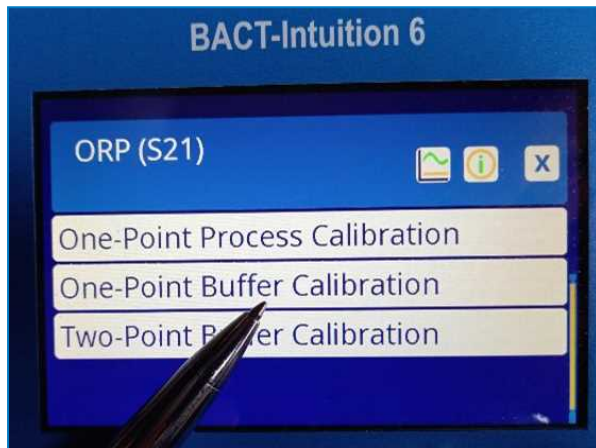

Choose your method and follow the steps on the screen.

One point calibration

- The sensor stays in the loop, so the regulation is not interrupted
- Take a sample, analyze it, and then enter the actual value of the process.

One point buffer calibration

- The sensor is removed from the process, so the regulation is topped during the calibration
- Remove the sensor from the process, rinse it off, and place it in the buffer solution.

Example one point buffer

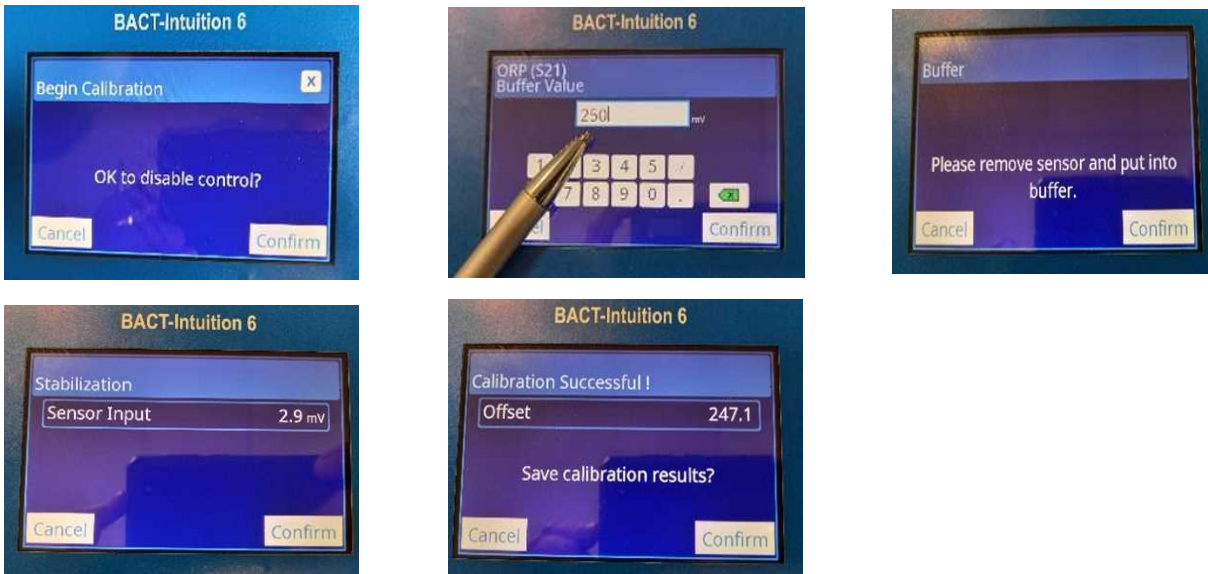

 During the stabilization steps, when the signal from the sensor is stable, the controller will automatically move to the next step. If it doesn't stabilize, you may manually go to the next step by pressing the Confirm key.

Two point buffer calibration

- Very similar to one point buffer calibration, except that you need two different buffer solutions
- The sensor is removed from the process, so the regulation is stopped during the calibration
- Remove the sensor from the process, rinse it off, and place it in the first buffer solution
- Then, remove the sensor from the first buffer, rinse it off and place it in the second buffer solution

REPLACING THE FUSE



CAUTION

Disconnect power to the controller before opening front panel.

Troubleshooting



CAUTION

Disconnect power to the controller before opening the front panel.

Troubleshooting and repair of malfunctioning controller should only be attempted by qualified personnel using caution to ensure safety and limit unnecessary further damage. Contact the factory.

CALIBRATION FAILURE

The calibration will fail if the adjustment to the gain is outside a certain range.

Possible cause	Corrective action
Dirty electrode	Clean electrode
Improper wiring of sensor to controller	Correct wiring
Wrong cell constant entered	Program the controller cell constant setting at the value that matches the electrode being used
Incorrect temperature reading or setting	Ensure that the temperature is accurate
Incorrect cable length or wire gauge setting	Set to the correct values
Faulty electrode	Replace electrode

ALARM MESSAGES

Alarm messages will include the name of the input or output as defined in the settings menu, the hardware identifying type and number (S for sensor input, D for digital input, R for relay output, A for analog input) and the type of alarm.

High or High-High Alarm

Occurs if the conductivity rises above the high conductivity alarm set points. If your unit is programmed for an alarm relay output, the relay alarm will activate. The controller will continue to check the conductivity, and any outputs using the conductivity well remain active.

Possible cause	Corrective action
Dirty sensor	Clean sensor (see "Maintenance" on page 38)
Faulty bleed valve	Repair or replace valve
Faulty sensor	Replace sensor

Possible cause	Corrective action
Improper wiring of valve or controller	Correct wiring
Conductivity rose over alarm limit while biocide lockout occurred	Allow normal bleed to occur
Clogged bleed line	Clean
Faulty bleed relay	Replace

Low or Low-Low Alarm

Occurs if the conductivity drops below the low conductivity alarm set points. If your unit is programmed for an alarm relay output, the relay alarm will activate. The controller will continue to check the conductivity, and any outputs using the conductivity well remain active.

Possible cause	Corrective action
Sensor disconnected	Reconnect. Check cable for continuity.
Sensor dry	Check tee for obstruction. Verify flow. Change location of electrode.
Pre-bleed set too low	Check pre-bleed setting
Bleed valve stuck open	Repair or replace bleed valve
Faulty electrode	Replace sensor
Improper wiring of electrode	Correct wiring
Faulty bleed relay	Replace relay

Output Timeout

This error condition will stop control. It is caused by the output (either relay or analog) being activated for longer than the programmed time limit.

Possible cause	Corrective action
Programmed value too low for normal conditions	Increase time limit
Bleed flow rate too low	Check for clogged strainer. Check for insufficient pressure differential.
Bleed valve not opening	Check for faulty bleed valve. Check bleed valve wiring. Check controller relay.
Sensor not responding	Clean sensor, check wiring, replace sensor.



Range Alarm

It indicates that the conductivity signal from the sensor is out of the normal range of 0-30,000. This error condition will stop conductivity control. This prevents controlling based upon a false conductivity reading. If the temperature goes into range alarm (outside -5 to 90 °C for tower, -5 to 220 °C for boiler), then the controller will go into manual temperature compensation using the default temperature setting.

Possible cause	Corrective action
Sensor wires shorted	Disconnect short
Faulty sensor	Replace sensor
Faulty controller	Replace or repair controller

Sensor fault

This error indicates that the signal from the sensor is no longer valid at all. This error condition will stop conductivity control.

Possible cause	Corrective action
Sensor wires shorted	Disconnect short
Faulty sensor	Replace sensor
Faulty controller	Replace or repair controller

Input failure

This alarm indicates that the sensor input circuit is no longer working. This error condition will stop conductivity control.

Possible cause	Corrective action
Faulty controller	Replace or repair controller



BCP3D

FURTHER ASSISTANCE & INFORMATION

More information

REFERENCE LITERATURE

- Eurovent 9-5 (6) Recommended Code of Practice to keep your Cooling System efficient and safe. Eurovent/Cecomaf, 2002, 30p.
- Guide des Bonnes Pratiques, Legionella et Tours Aéroréfrigérantes. Ministères de l'Emploi et de la Solidarité, Ministère de l'Economie des Finances et de l'Industrie, Ministère de l'Environnement, Juin 2001, 54p.
- Voorkom Legionellose. Ministerie van de Vlaamse Gemeenschap. December 2002, 77p.
- Legionnaires' Disease. The Control of Legionella Bacteria in Water Systems. Health & Safety Commission. 2000, 62p.
- Hygienische Anforderungen an raumluftechnische Anlagen. VDI 6022.

INTERESTING WEBSITES

Baltimore Aircoil Company	www.BaltimoreAircoil.com
BAC Service website	www.BACservice.eu
Eurovent	www.eurovent-certification.com
European Working Group on Legionella Infections (EWGLI)	EWGLI
ASHRAE	www.ashrae.org
Uniclimate	www.uniclimate.fr
Association des Ingénieurs et techniciens en Climatique, Ventilation et Froid	www.aicvf.org
Health and Safety Executive	www.hse.gov.uk

ORIGINAL DOCUMENTATION



This manual is originally made in English. Translations are provided for your convenience. In the event of discrepancies, the English original text shall prevail over the translation.



A series of horizontal dotted lines for writing, spanning the width of the page.



A series of horizontal dotted lines for writing, spanning the width of the page.

COOLING TOWERS

CLOSED CIRCUIT COOLING TOWERS

ICE THERMAL STORAGE

EVAPORATIVE CONDENSERS

HYBRID PRODUCTS

PARTS, EQUIPMENTS & SERVICES

BLUE by nature
GREEN at heart



www.BaltimoreAircoil.com

Europe@BaltimoreAircoil.com

Please refer to our website for local contact details.

Industriepark - Zone A, B-2220 Heist-op-den-Berg, Belgium

© Baltimore Aircoil International nv